

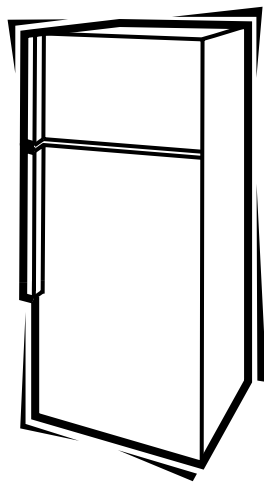

TECHNICAL SERVICE GUIDE

2001 Top Mount No Frost
15-18 Cu. Ft. Refrigerators



MODEL SERIES:

GTR
GTS
GTT
HTR
HTS
HTT





IMPORTANT SAFETY NOTICE

The information in this service guide is intended for use by individuals possessing adequate backgrounds of electrical, electronic, and mechanical experience. Any attempt to repair a major appliance may result in personal injury and property damage. The manufacturer or seller cannot be responsible for the interpretation of this information, nor can it assume any liability in connection with its use.

WARNING

To avoid personal injury, disconnect power before servicing this product. If electrical power is required for diagnosis or test purposes, disconnect the power immediately after performing the necessary checks.

RECONNECT ALL GROUNDING DEVICES

If grounding wires, screws, straps, clips, nuts, or washers used to complete a path to ground are removed for service, they must be returned to their original position and properly fastened.

GE Consumer Home Services Training
Technical Service Guide
Copyright © 2001

All rights reserved. This service guide may not be reproduced in whole or in part in any form without written permission from the General Electric Company.

Table of Contents

Specifications, 15-16 Cu. Ft.	2
Specifications, 17-18 Cu. Ft.	3
Nomenclature	4
Warranty Information	5
Operating Characteristics	6
Mechanical Disassembly	7
Troubleshooting	16
Component Locator Views	20
Schematics	22

Specifications, 15-16 Cu. Ft.

DISCONNECT POWER CORD BEFORE SERVICING

IMPORTANT - RECONNECT ALL GROUNDING DEVICES

All parts of this appliance capable of conducting electrical current are grounded. If grounding wires, screws, straps, clips, nuts or washers used to complete a path to ground are removed for service, they must be returned to their original position and properly fastened.

ELECTRICAL SPECIFICATIONS

Temperature Control (Position 5)	31.5-16.5°F
Defrost Control	12 hrs @ 33 min
Defrost Thermostat	64-23°F
Electrical Rating: 115V. AC 60Hz.	6.5 Amp
Maximum Current Leakage	0.75 mA
Maximum Ground Path Resistance	0.14 Ohms
Energy Consumption -15	37 KWH/mo
-16	38 KWH/mo

NO LOAD PERFORMANCE

Control Position 5/C	-15		-16	
and Ambient Temperature of	70°F	90°F	70°F	90°F
Fresh Food, °F	33-39	36-40	31-37	36-40
Frozen Food, °F	(-4) -2	(-2) -2	(-6) -0	(-4) -0
Run Time, %	23-33	36-52	23-33	36-52

REFRIGERATION SYSTEM

Refrigerant Charge (R134a)	4.12 ounces
Compressor	780 BTU/hr
Minimum Compressor Capacity	19 inches
Minimum Equalized Pressure	
@70°F	37.8 PSIG
@90°F	50.7 PSIG

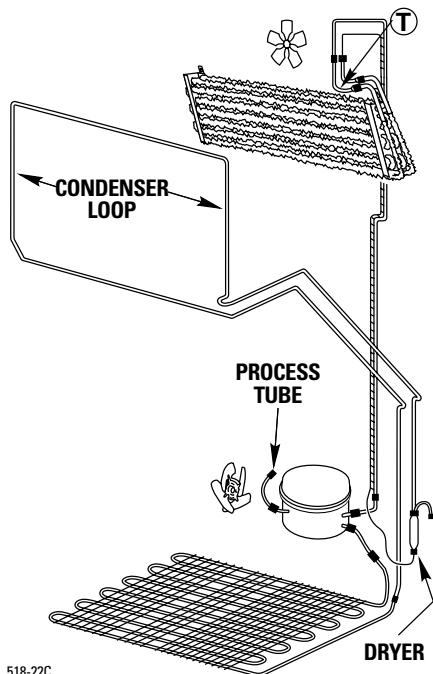

IMPORTANT SAFETY NOTICE

This information is intended for use by individuals possessing adequate backgrounds of electrical, electronic and mechanical experience. Any attempt to repair a major appliance may result in personal injury and property damage. The manufacturer or seller cannot be responsible for the interpretation of this information, nor can it assume any liability in connection with its use.

INSTALLATION

Clearance must be provided for air circulation

AT TOP	1-inch
AT SIDES	3/4-inch
AT REAR	1-inch

AIR FLOW

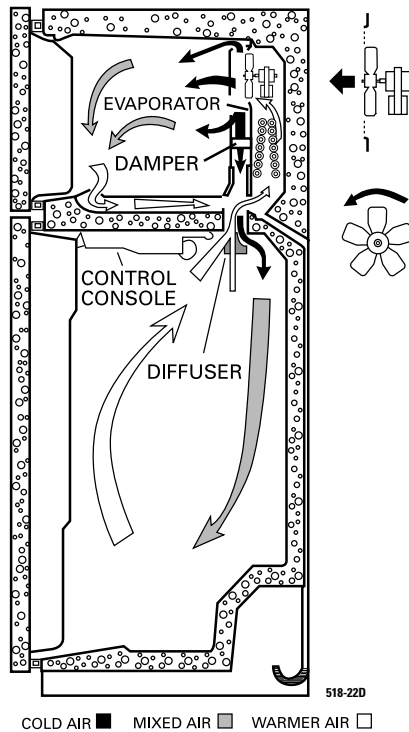

REPLACEMENT PARTS

Temperature Control	WR09X0547
Relay	WR07X0259
Overload	WR08X0122
Defrost Control	WR09X10047
Defrost Thermostat	WR50X10021
Defrost Heater	WR51X10038
Condenser Fan Motor	WR60X10021
Evaporator Fan Motor	WR60X10046
Run Capacitor	WR62X0080

Specifications, 17-18 Cu. Ft.

DISCONNECT POWER CORD BEFORE SERVICING
IMPORTANT - RECONNECT ALL GROUNDING DEVICES

All parts of this appliance capable of conducting electrical current are grounded. If grounding wires, screws, straps, clips, nuts or washers used to complete a path to ground are removed for service, they must be returned to their original position and properly fastened.

ELECTRICAL SPECIFICATIONS

Temperature Control (Position 5)	31.5-16.5°F
Defrost Control	15 hrs @ 34 min
Defrost Thermostat	64-23°F
Electrical Rating: 115V AC 60Hz/100V AC 50Hz	6.5 Amp
Maximum Current Leakage	0.75 mA
Maximum Ground Path Resistance	0.14 Ohms
Energy Consumption -17	39 KWH/mo
-18	40 KWH/mo

NO LOAD PERFORMANCE

Control Position 5/C and Ambient Temperature of	-17		-18	
	70°F	90°F	70°F	90°F
Fresh Food, °F	33-39	37-41	33-39	36-40
Frozen Food, °F	(-2) -4	(-1) -3	(-4) -2	(-4) -0
Run Time, %	26-36	40-56	26-36	40-56

REFRIGERATION SYSTEM

Refrigerant Charge (R134a)	4.12 ounces
Compressor	780 BTU/hr
Minimum Compressor Capacity	19 inches
Minimum Equalized Pressure	
@70°F	37.8 PSIG
@90°F	50.7 PSIG

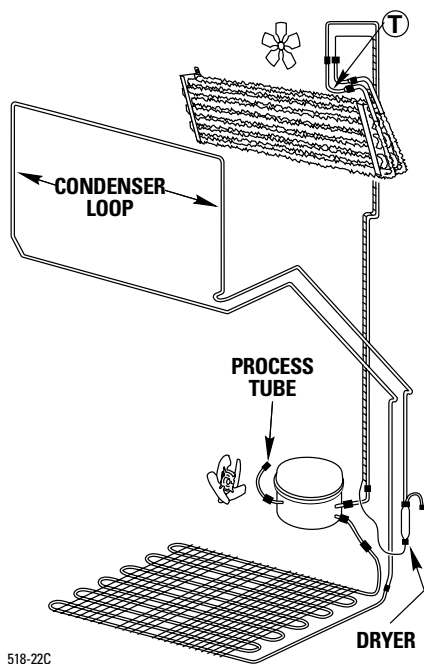

518-22C

IMPORTANT SAFETY NOTICE

This information is intended for use by individuals possessing adequate backgrounds of electrical, electronic and mechanical experience. Any attempt to repair a major appliance may result in personal injury and property damage. The manufacturer or seller cannot be responsible for the interpretation of this information, nor can it assume any liability in connection with its use.

INSTALLATION

Clearance must be provided for air circulation:
 AT TOP 1-inch
 AT SIDES 3/4-inch
 AT REAR 1-inch

AIR FLOW

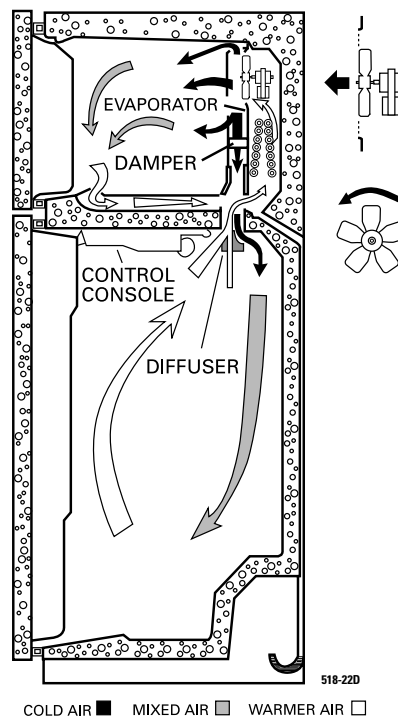

518-22D

REPLACEMENT PARTS

Temperature Control	WR09X0547
Relay	WR07X0259
Overload	WR08X0122
Defrost Control	WR09X10049
Defrost Thermostat	WR50X10021
Defrost Heater	WR51X10038
Condenser Fan Motor (17)	WR60X10021
Condenser Fan Motor (18)	WR60X10048
Evaporator Fan Motor	WR60X10046
Run Capacitor	WR62X0080

Nomenclature

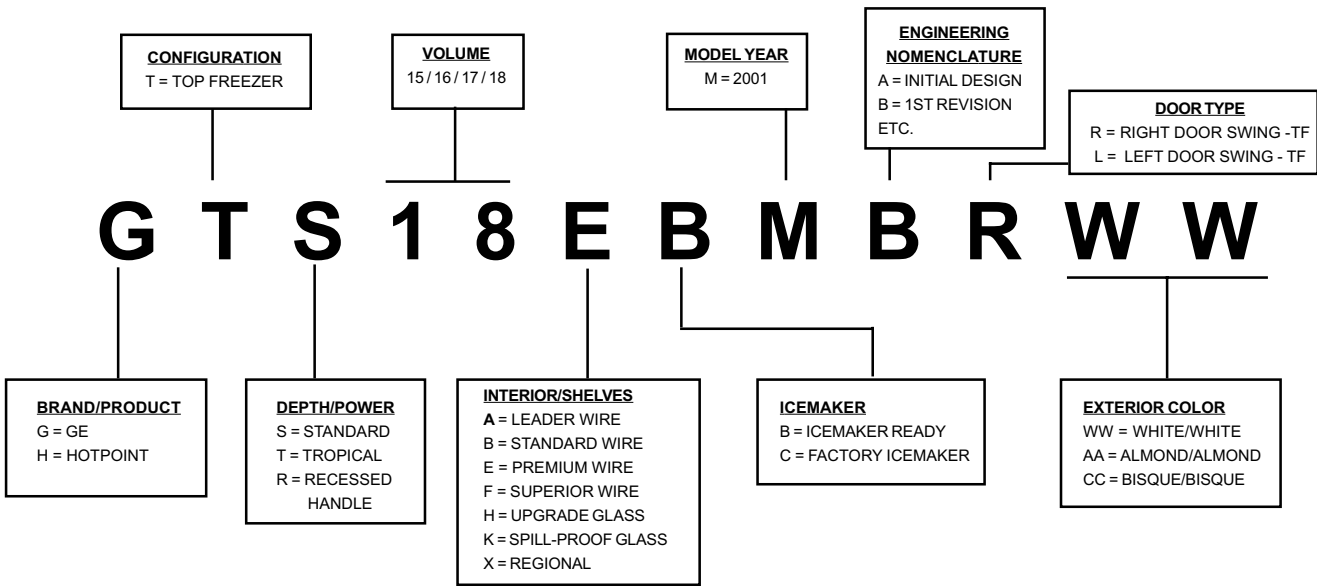

Nomenclature (tag)



GEA01027

Mini Manual Location

Warranty Information

Refrigerator Warranty. (For customers in the United States)



All warranty service provided by our Factory Service Centers, or an authorized Customer Care® technician. To schedule service, on-line, 24 hours a day, contact us at www.GEAppliances.com, or call 800-GE-CARES.

Staple your receipt here. Proof of the original purchase date is needed to obtain service under the warranty.

For The Period Of:	GE Will Replace:
One Year From the date of the original purchase	Any part of the refrigerator which fails due to a defect in materials or workmanship. During this full one-year warranty , GE will also provide, free of charge , all labor and in-home service to replace the defective part.
Five Years From the date of the original purchase	Any part of the sealed refrigerating system (the compressor, condenser, evaporator and all connecting tubing) which fails due to a defect in materials or workmanship. During this additional four-year warranty , GE will also provide, free of charge , all labor and in-home service to replace the defective part.

What GE Will Not Cover:

- Service trips to your home to teach you how to use the product.
- Improper installation.
- Failure of the product if it is abused, misused, or used for other than the intended purpose or used commercially.
- Loss of food due to spoilage.
- Replacement of house fuses or resetting of circuit breakers.
- Damage to the product caused by accident, fire, floods or acts of God.
- Incidental or consequential damage caused by possible defects with this appliance.

This warranty is extended to the original purchaser and any succeeding owner for products purchased for home use within the USA. In Alaska, the warranty excludes the cost of shipping or service calls to your home.

Some states do not allow the exclusion or limitation of incidental or consequential damages. This warranty gives you specific legal rights, and you may also have other rights which vary from state to state. To know what your legal rights are, consult your local or state consumer affairs office or your state's Attorney General.

Warrantor: General Electric Company, Louisville, KY 40225

Operating Characteristics

Note:

- Refer to Component Locator Views.
- Refer to Schematics.

Component Description

The compressor and dryer are located in the machine compartment at the bottom, rear of the unit. The condenser is located under the unit. The evaporator is located in the freezer compartment on the back wall.

The capillary is soldered to the compressor suction line. The capillary is also clipped to the suction line near the dryer. This arrangement serves as a heat exchanger.

The temperature control and defrost control are located in the control console. The control console is located in the top of the fresh food compartment. The evaporator fan is located in freezer compartment behind the rear panel.

Electrical Operation

115V is provided from the power source to the temperature control. The temperature control is a thermostatic switch that closes when the fresh food compartment temperature is higher than the control setting. When closed, the temperature control provides 115V to the defrost control. The defrost control contains a motor/cam mechanism that switches the defrost control between defrost mode and cooling mode. When in cooling mode, the defrost control provides 115V to the compressor, condenser fan, and evaporator fan. The compressor, condenser fan, and evaporator fan should always operate at the same time.

Defrost Operation

NOTE: 15-16 Cu. Ft. defrost control 12 hours @ 33 minutes. 17-18 Cu. Ft. defrost control 15 hours @ 34 minutes.

The automatic defrost function is controlled by the defrost control. The defrost control contains a motor/cam mechanism that switches the defrost control between defrost mode and cooling mode.

The defrost control motor/cam mechanism operates only when the temperature control (switch) is closed. After 15 hours of motor/cam mechanism runtime in cooling mode, the defrost control switches to defrost mode. The defrost control will stay in defrost mode, providing 115V to the heater for 34 minutes of motor/cam mechanism runtime. The defrost thermostat switch is mounted on the evaporator, and when closed completes the neutral side of the defrost heater circuit. The defrost thermostat switch opens when the evaporator temperature raises to 64°F and closes when the evaporator temperature lowers to 23°F. The defrost thermostat switch typically opens during the defrost cycle, preventing the heater from defrosting for the full 34 minutes. The purpose for the 34-minute defrost mode at the defrost control is to prevent the compressor from operating and refreezing any water that may be dripping from the evaporator.

Air Movement

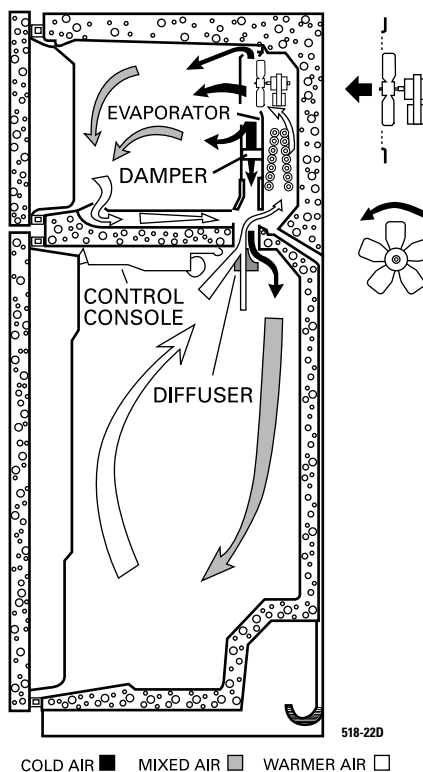

Mechanical Disassembly

Table of Contents

Door Gasket	8
Freezer Door	8
Refrigerator Door	8
Temperature Control	8
Defrost Control	9
Light Switch	9
Light and Light Socket	9
Freezer Floor Panel and Evaporator Cover	10
Defrost Thermostat	10
Defrost Heater	11
Evaporator (Soldering Method)	11
Evaporator (LOKRING Method)	12
Evaporator Fan	13
Condenser Fan	13
PTCR Relay/Overload Cover (Compressor)	13
PTCR Relay (Compressor)	13
Overload (Compressor)	14
Capacitor (Compressor)	14
Compressor	14

Door Gasket

Note: The door gasket is held in a retainer channel.

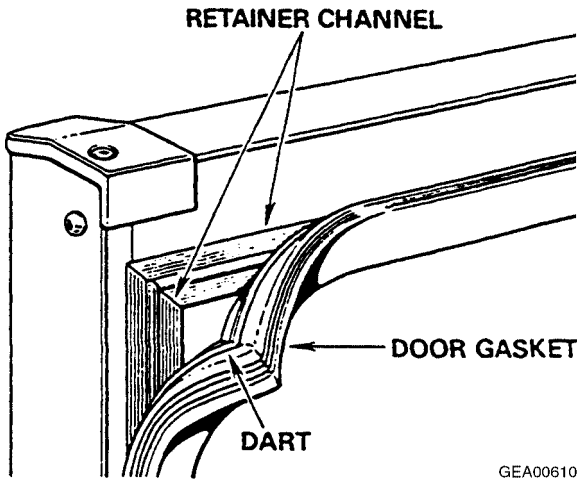

1. Pull the old gasket out of the channel.
2. Soak the new gasket in warm water to make it more pliable.
3. Using the back of a teaspoon, push the barbed edge of the gasket into the retaining channel.

Freezer Door

1. Remove all food from the inner door liner.

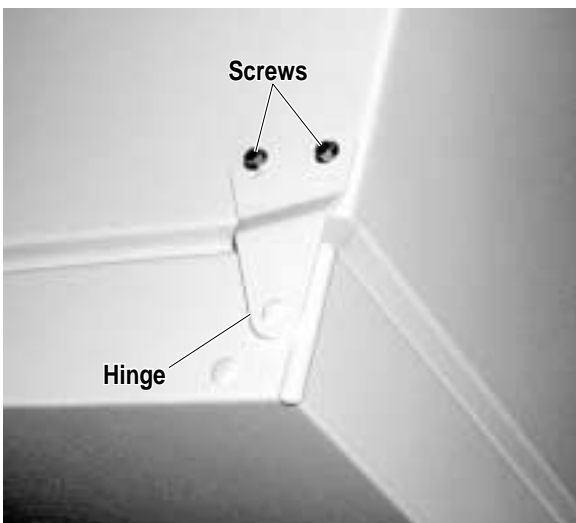

2. Remove 2 screws and the top hinge from the cabinet.

Note: Do **not** lose spacers on center hinge pin. Spacers are needed for proper door adjustment.

3. Open the door and lift it off the center hinge pin to remove.

Refrigerator Door

1. Remove all food from the inner door liner.

Note: Do **not** lose spacers on center hinge pin and lower hinge pin. Spacers are needed for proper door adjustment.

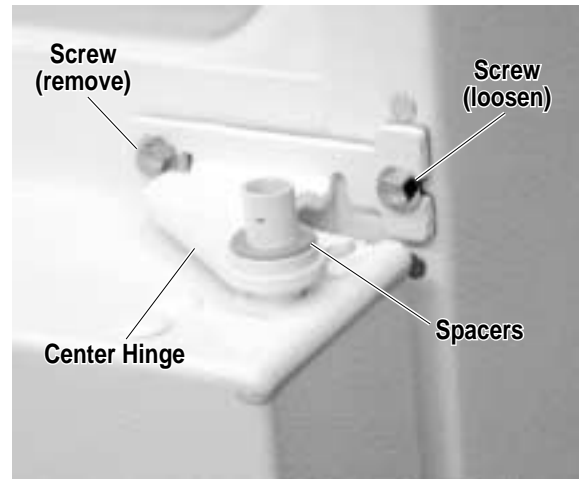

2. Loosen the outer screw, remove the inner screw. Slide the hinge out of the outer screw and remove .
3. Open the door, lift it off the bottom hinge and remove.

Temperature Control

1. Remove 2 screws and lower the control console.

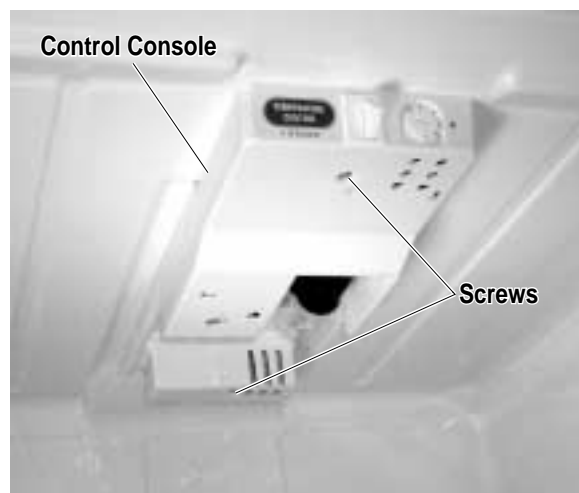

2. Remove cardboard insulator, disconnect the harness connector and remove the control console.

3. Remove the temperature adjustment knob.
4. Disconnect the wire leads and ground wire from the temperature control.

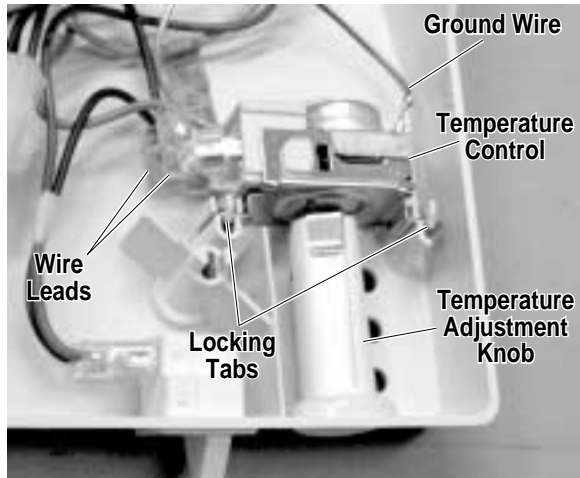

GEA01031

5. Press the locking tabs back and slide the temperature control out of the control console.

Defrost Control

1. Remove the control console (see Temperature Control procedure).
2. Disconnect the wiring harness connector from the defrost control.

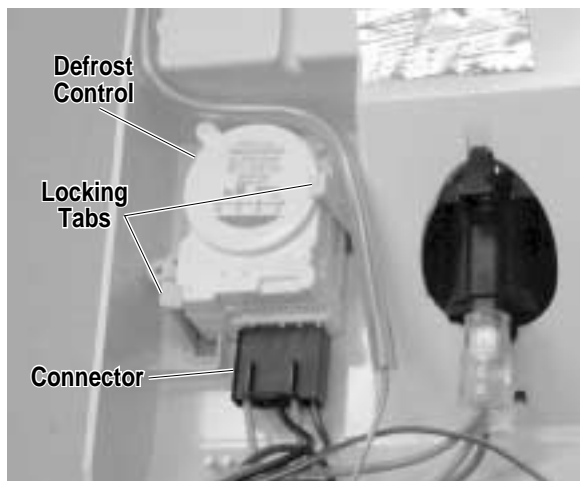

GEA01030

3. Press the locking tabs back and slide the defrost control out of the control console.

Light Switch

1. Insert a small flat screwdriver under the right side of the light switch and release the switch locking tab.

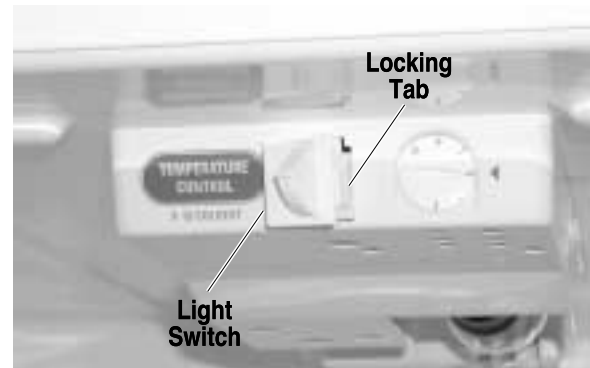

GEA01033

2. Pull the switch out, disconnect the wire leads and remove.

Light and Light Socket

1. Unscrew the light bulb and remove.
2. Remove the control console (see Temperature Control procedure).

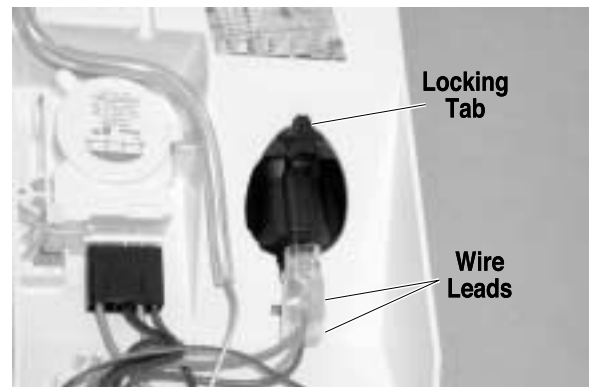

GEA01032

3. Disconnect the wire leads from the light socket.
4. Press in on the socket locking tab and push the light socket out of the control console.

Freezer Floor Panel and Evaporator Cover

1. Remove all shelves.

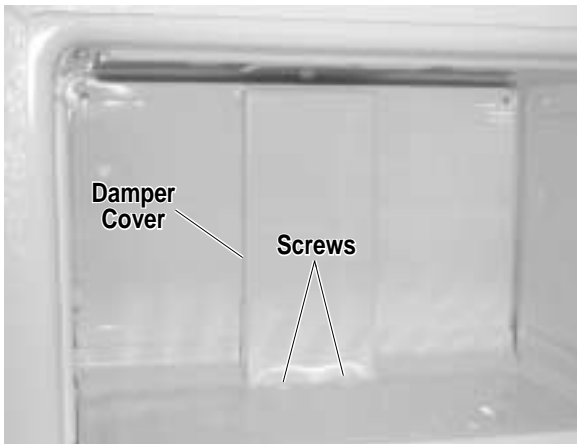

GEA01034

2. Remove 2 screws from the bottom of the damper cover.
3. Slide the damper cover up to release the top catches and remove.

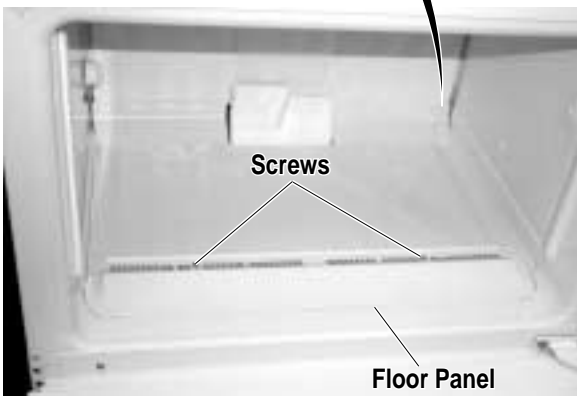
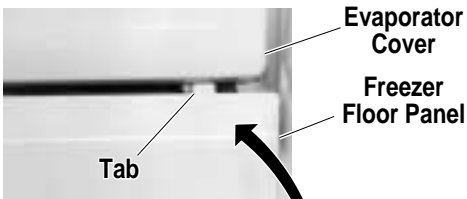

GEA01035

4. Remove 2 screws from the freezer floor panel.

Note: It may be necessary to press the rear edge of the freezer floor panel down while lifting the front edge up in order to disengage the rear tabs from the evaporator cover.

5. Lift the front edge of the freezer floor panel up until the rear tabs release from the evaporator cover.

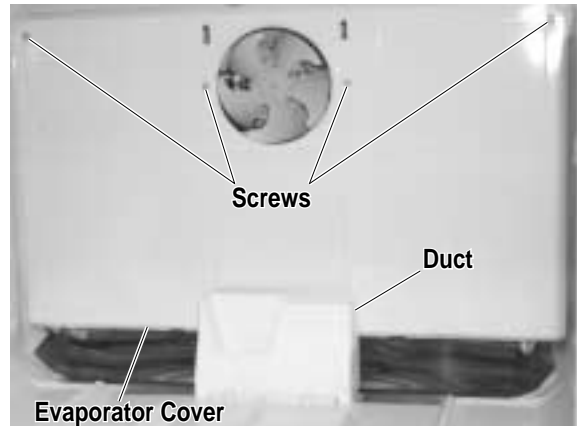

GEA01038

6. Pull the duct out of the freezer bottom.
7. Remove 4 screws and the evaporator cover.

Defrost Thermostat

1. Remove the evaporator cover (see Freezer Floor Panel and Evaporator Cover procedure).

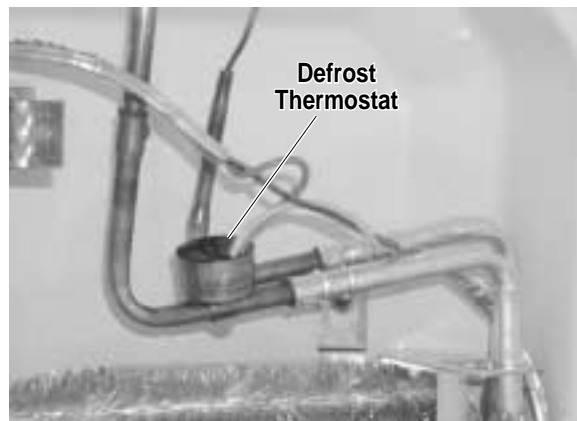

GEA01040

Note: The thermostat has a metal clip that fastens it to the line.

2. Remove the thermostat from the line.
3. Cut the thermostat lead wires and remove the thermostat.

Defrost Heater

1. Remove the evaporator cover (see Freezer Floor Panel and Evaporator Cover procedure).

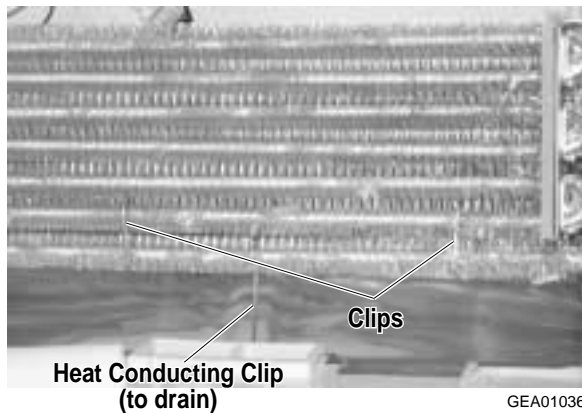

Note: Heat conducting clip assists in defrosting drain. During assembly, clip must be installed on evaporator and in drain to prevent drain from freezing closed.

2. Remove 2 clips and the heat conducting clip from the evaporator.
3. Bend the aluminum tabs back (located at each end of the defrost heater) and lower the heater out of the evaporator.



4. Disconnect 2 lead wires and remove the heater.

Evaporator (Soldering Method)

1. Recover the refrigerant.
2. Remove the evaporator cover (see Freezer Floor Panel and Evaporator Cover procedure).
3. Remove the defrost thermostat (see Defrost Thermostat procedure).

4. Remove the defrost heater (see Defrost Heater procedure).
5. Disconnect ground wire from evaporator and position all wiring to allow for evaporator removal.

CAUTION:

- If desoldering the evaporator, **HEAT SHIELD P/N WR49X10025** must be used to prevent damage to freezer liner.
- Protect wiring from heat during desoldering and resoldering.
- To prevent damage to the capillary tube, the capillary tube must be desoldered first.

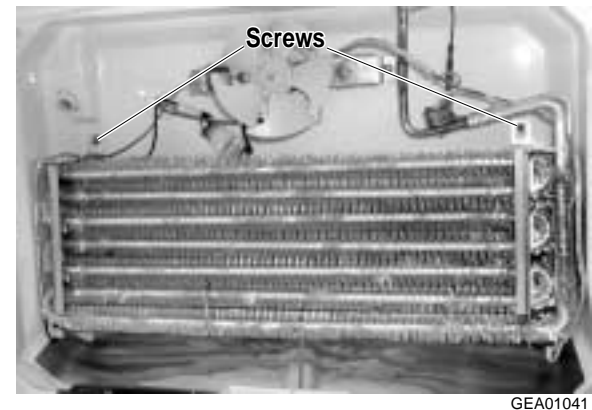

6. Remove 2 screws that hold the evaporator to the cabinet.
7. Desolder the capillary tube from the evaporator.
8. Desolder the suction line. Use a pair of pliers to hold the evaporator.
9. Remove evaporator.
10. Using a file, score the capillary tube just above the old solder and break the solder-covered section off. This will help prevent the capillary tube from becoming plugged when resoldering.
11. Position the new evaporator in the cabinet. Insert the suction line and capillary tube into the evaporator.
12. Solder the suction line to the evaporator using silfos.
13. Solder the capillary tube to the evaporator using silfos.

Note: Heat conducting clip assists in defrosting drain. During assembly, clip must be installed on evaporator and in drain to prevent drain from freezing closed.

14. Install a replacement dryer.
15. Evacuate and recharge the system using currently accepted procedures.

Evaporator (LOKRING Method)

1. Recover the refrigerant.
2. Remove the evaporator cover (see Freezer Floor Panel and Evaporator Cover procedure).
3. Remove the defrost thermostat (see Defrost Thermostat procedure).
4. Remove the defrost heater (see Defrost Heater procedure).
5. Disconnect ground wire from evaporator and position all wiring to allow for evaporator removal.

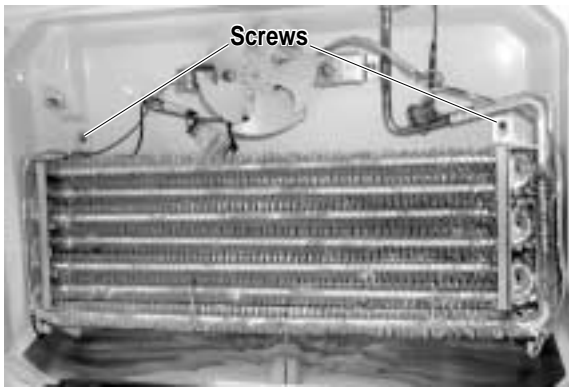

GEA01041

6. Remove 2 screws that hold the evaporator to the cabinet.

CAUTION: Tubing must be clean and free from burrs when using LOKRING.

NOTE: LOKRING connector P/N WR97X10021 must be used. Two LOKRING connectors are required.

7. Replace the evaporator using the LOKRING method (see Pub # 31-9067).
 - Cut the copper lines of the old evaporator as close as possible to the aluminum evaporator tubes.
 - Cut the copper lines of the new evaporator 1 1/8 inch from the edge of the aluminum evaporator tubes.
 - Defrost thermostat can be moved from the horizontal part of the copper line, to the vertical part just above the bend.

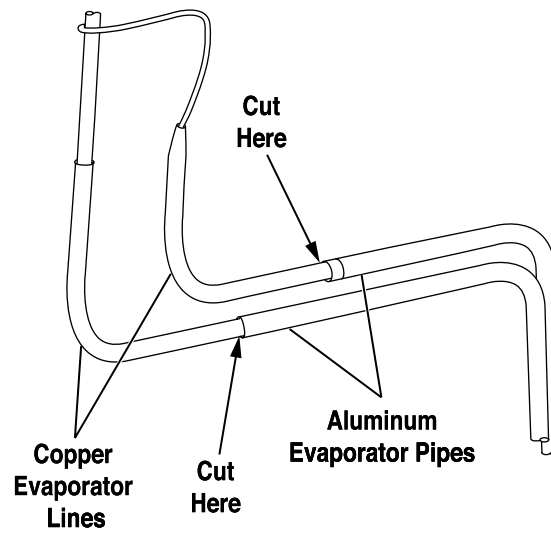

OLD EVAPORATOR

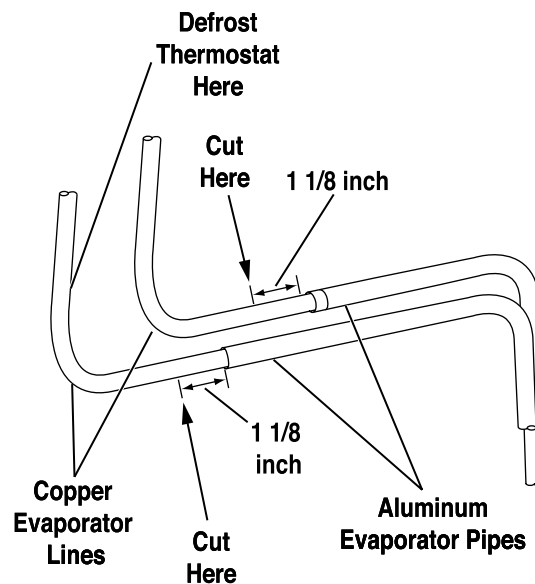

NEW EVAPORATOR

GEA01108

Note: Heat conducting clip assists in defrosting drain. During assembly, clip must be installed on evaporator and in drain to prevent drain from freezing closed.

8. Install a replacement dryer.
9. Evacuate and recharge the system using currently accepted procedures.

Evaporator Fan

1. Remove the evaporator cover (see Freezer Floor Panel and Evaporator Cover procedure).
2. Carefully pull the fan off of the motor shaft.

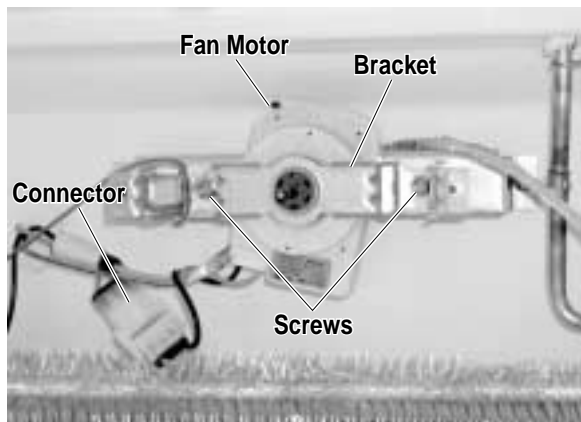

GEA01039

3. Disconnect the fan motor connector.
4. Remove 2 screws, bracket, and fan motor.

Condenser Fan

1. Remove the machine compartment cover.
2. Disconnect the fan motor connector.

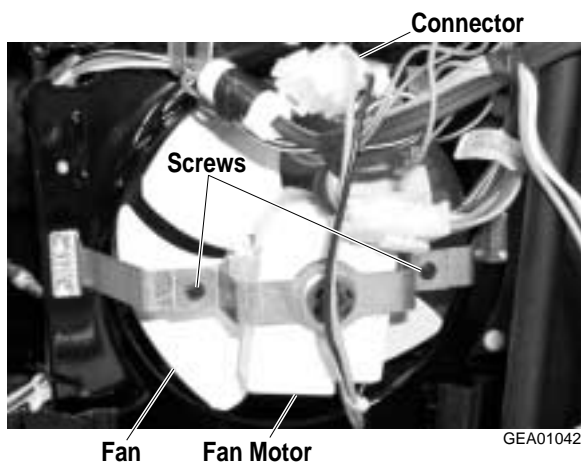

GEA01042

3. Carefully push the fan off of the motor shaft.
4. Remove 2 screws, bracket, and the fan motor.

PTCR Relay/Overload Cover (Compressor)

1. Remove the machine compartment cover.



GEA01044

2. Insert a flat screwdriver under the cover retainer clip, pry up and remove.
3. Remove the cover.

PTCR Relay (Compressor)

1. Remove the PTCR relay/overload cover (see procedure).

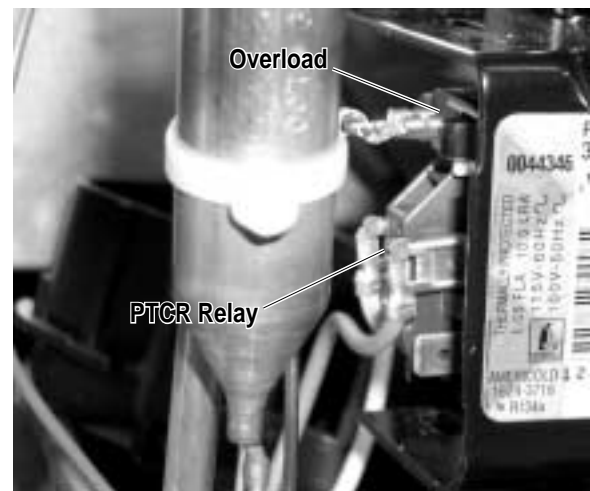

GEA01045

2. Pull the PTCR relay straight out from the compressor.
3. Disconnect the wire leads from the relay.

Overload (Compressor)

1. Remove the PTCR relay/overload cover (see procedure).
2. Remove the PTCR relay (see procedure).
3. Pull the overload straight out from the compressor.
4. Disconnect the wire lead from the overload.

Capacitor (Compressor)

1. Remove the machine compartment cover.

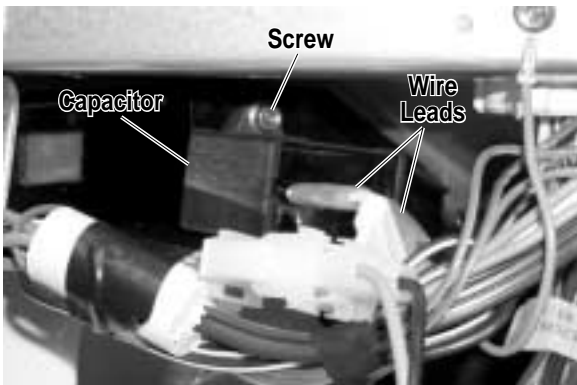

2. Disconnect the wire leads from the capacitor.
3. Discharge the capacitor with a screwdriver.
4. Remove 1 screw and the capacitor.

Compressor

NOTE: Capillary tube must be clipped to compressor suction line near the dryer. If capillary tube is not clipped to suction line, a knocking noise may occur during compressor operation.

Refer to the compressor replacement instructions included with the replacement compressor.

Notes

Troubleshooting

Note:

- Refer to Operating Characteristics before choosing a troubleshooting procedure.
- Refer to Schematics.
- Refer to Component Locator Views.

Compressor Knock

1. **Capillary tube not clipped to suction line.** Check to see that capillary tube is clipped to the suction line near the dryer.

Low or No Cooling

Check for the following problems:

1. **Condenser dirty/clogged.** Unplug unit and clean condenser and underside of refrigerator.
2. **Interior lights remain on.** Check to see that interior lights turn off when door switch is pressed.
3. **Door gasket does not seal.** Check for damaged or leaking door gasket.
4. **Compressor does not operate.** Go to Compressor Does Not Operate troubleshooting.
5. **Condenser fan does not operate.** Go to Condenser Fan Does Not Operate troubleshooting.
6. **Evaporator fan does not operate.** Go to Evaporator Fan Does Not Operate troubleshooting.
7. **Evaporator is frosted.** Go to Defrost System Check.
8. **Duct (diffuser) is clogged between freezer compartment and fresh food compartment.** If fresh food compartment is warm and freezer is normal or too cold, duct (diffuser) may be clogged. Duct is accessed by removing freezer floor panel and air tower.
9. **Freezer floor panel vents clogged or air channels under freezer floor panel clogged.** Inspect vents in freezer floor panel

for clogging. Remove freezer floor panel to inspect air channels.

10. **Refrigeration system faulty.** Go to Refrigeration System Check.

Compressor Does Not Operate

Check for the following problems:

Note: The defrost control **must** be in cooling mode to operate the compressor (provide 115V to the compressor overload). It may be necessary to manually rotate the defrost control to cooling mode before checking for voltage at the compressor overload.

1. **115V not present at compressor overload.** If 115V is not present at the compressor overload, check for an open temperature control or an open defrost control (cooling mode - terminals 3 and 4 are closed). **Note:** The compressor, condenser fan, and evaporator fan should always operate at the same time. If the condenser fan is operating, the temperature control and defrost control are OK.
2. **Overload open.** High heat or high current draw will cause the overload to open. The overload should close when the temperature lowers to normal or when normal current draw is present.
3. **PTCR relay open.**
4. **Run capacitor faulty.**
5. **Open wire or faulty connector.** Refer to Schematics.
6. **Compressor motor faulty.** Check resistance across the compressor motor. Refer to Schematics for resistance values.
7. **Compressor mechanically stalled.**

Condenser Fan Does Not Operate

Check for the following problems:

1. **Condenser fan faulty.**

2. **115V not present at condenser fan.** The compressor, condenser fan, and evaporator fan should always operate at the same time. If the compressor is operating, the temperature control and defrost control are OK.
3. **Orange wire open on neutral side of condenser fan.** Refer to Schematics.

Evaporator Fan Does Not Operate

Check for the following problems:

1. **Evaporator fan faulty.**
2. **115V not present at evaporator fan.** The compressor, condenser fan, and evaporator fan should always operate at the same time. If the compressor and condenser fan are operating, the temperature control and defrost control are OK.
3. **Orange wire open on neutral side of evaporator fan.** Refer to Schematics and Strip Circuits.

Light Does Not Illuminate

Check for the following problems:

1. **Lamp faulty.**
2. **Door switch open.** Check continuity across the door switch with the wires disconnected.
3. **Open wire or faulty connector.** Refer to Schematics.

Defrost System Check (Freezer)

NOTE: 15-16 Cu. Ft. defrost control 12 hours @ 33 minutes. 17-18 Cu. Ft. defrost control 15 hours @ 34 minutes.

The automatic defrost function is controlled by the defrost control. The defrost control contains a motor/cam mechanism that switches the defrost control between defrost mode and cooling mode. The defrost control motor/cam mechanism operates only when the temperature control

(switch) is closed. After 15 hours of motor/cam mechanism runtime in cooling mode, the defrost control switches to defrost mode. The defrost control will stay in defrost mode, providing 115V to the heater for 34 minutes of motor/cam mechanism runtime. The defrost thermostat switch is mounted on the evaporator, and when closed completes the neutral side of the defrost heater circuit. The defrost thermostat switch opens when the evaporator temperature raises to 64°F and closes when the evaporator temperature lowers to 23°F. The defrost thermostat switch typically opens during the defrost cycle, preventing the heater from defrosting for the full 34 minutes. The purpose for the 34-minute defrost mode at the defrost control is to prevent the compressor from operating and refreezing any water that may be dripping from the evaporator.

Check for the following problems:

1. **Evaporator heater open.** Check resistance across the evaporator heater. Refer to Schematics for resistance values.
2. **Defrost thermostat switch stuck open.** The defrost thermostat switch opens when the evaporator temperature raises to 64°F and closes when the evaporator temperature lowers to 23°.
3. **Defrost control open in defrost mode.** Manually rotate the defrost control into defrost mode. Check for continuity across the defrost control between terminals 2 and 3. Refer to Schematics.
4. **Open wire or faulty connector.** Refer to Schematics.
5. **Clogged or frozen drain.** Check for a clogged or frozen drain. If frozen, see “Heat conducting clip not installed” below.
6. **Heat conducting clip not installed.** If the heat conducting clip is not installed on the evaporator and in the drain, the drain may freeze closed.

Refrigeration System Check

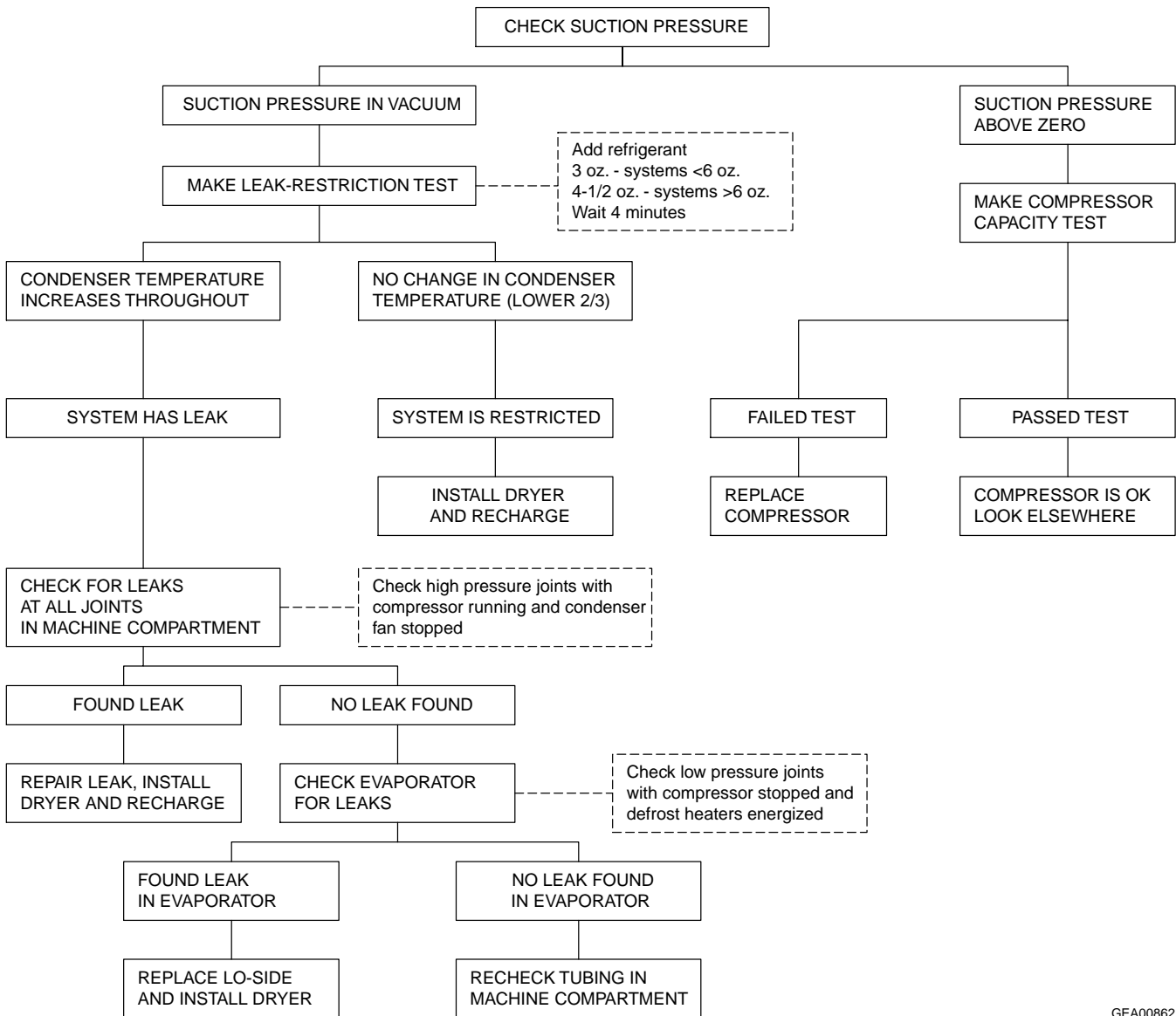

GEA00862

Component Locator Views

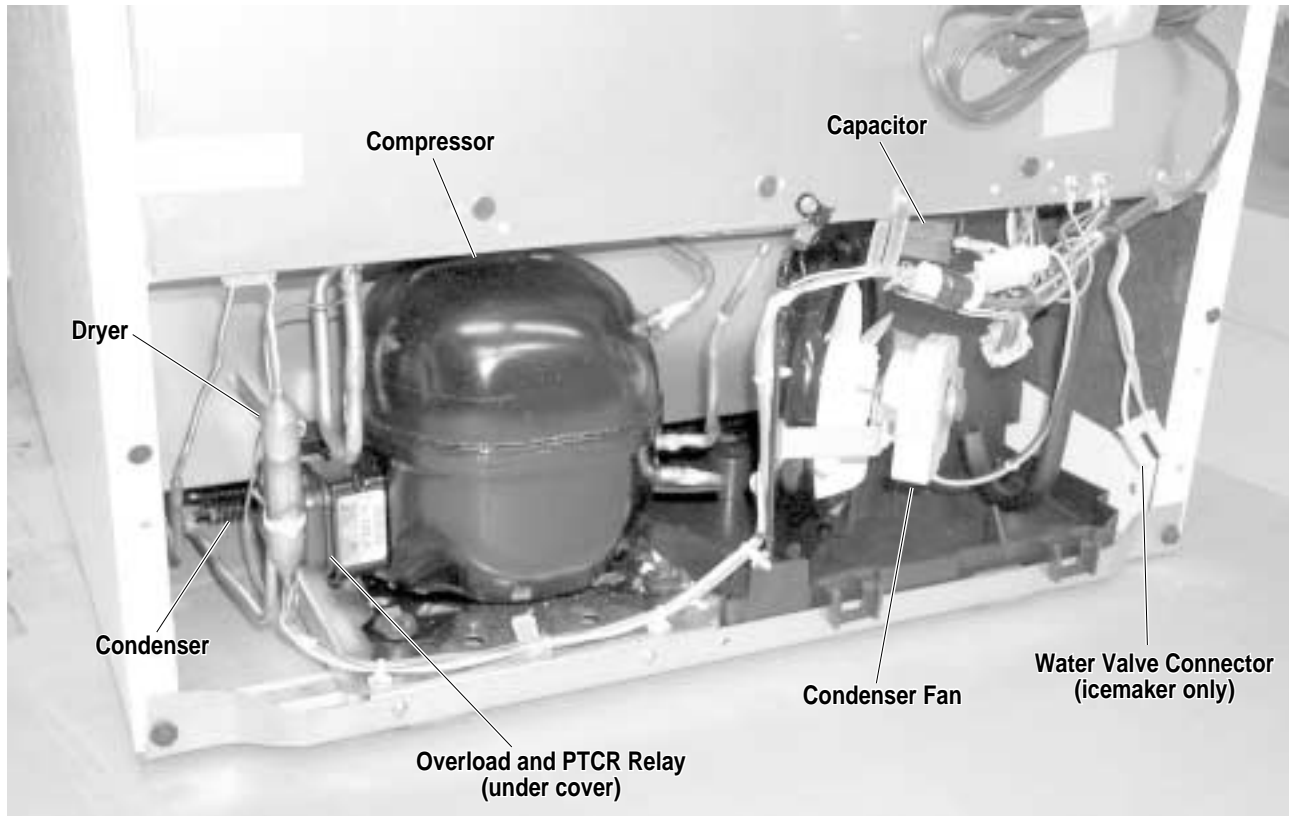

Figure 1 - Machine Compartment

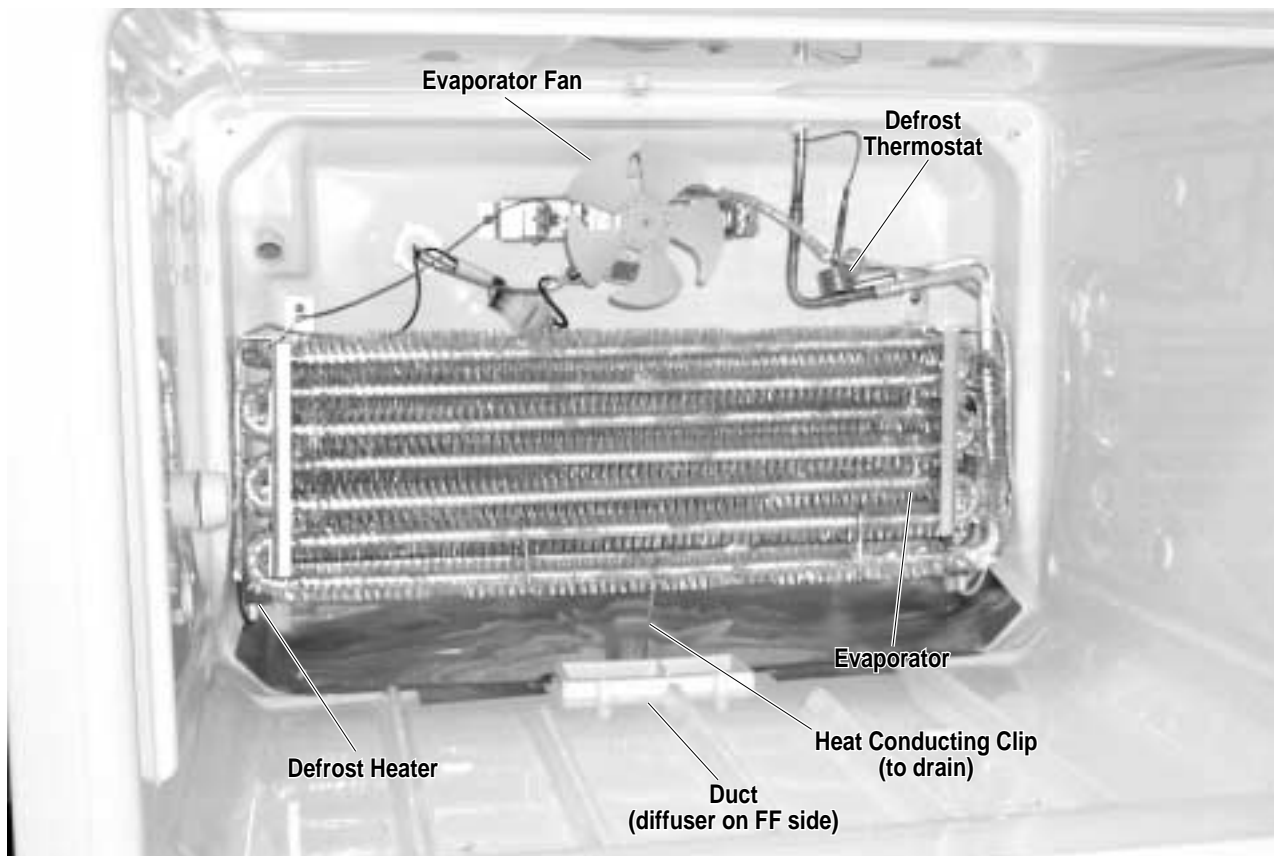
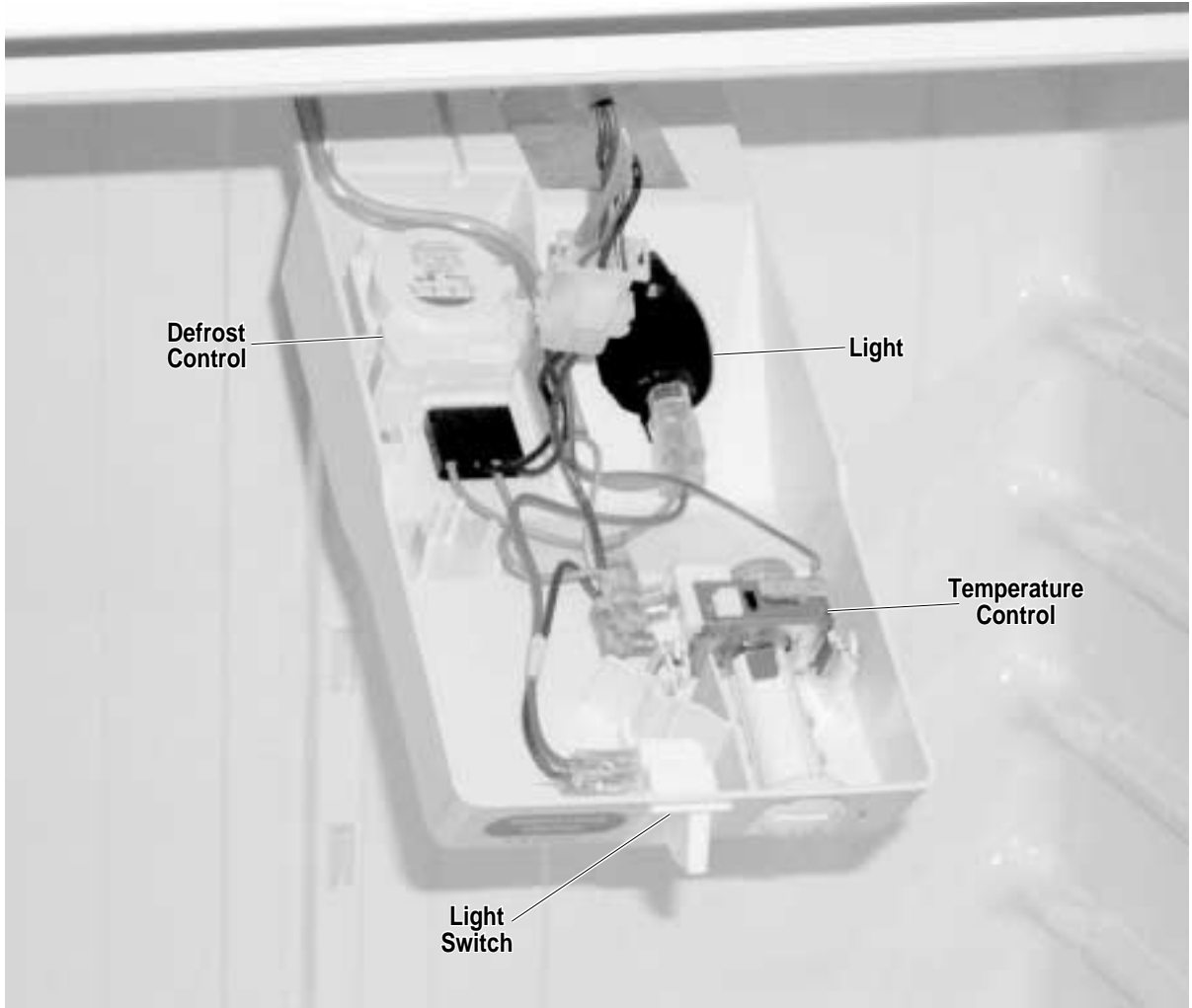

Figure 2 - Evaporator and Associated Parts

GEA01026



GEA01024

Figure 3 - Control Console

Schematics

15-16 Cu. Ft.

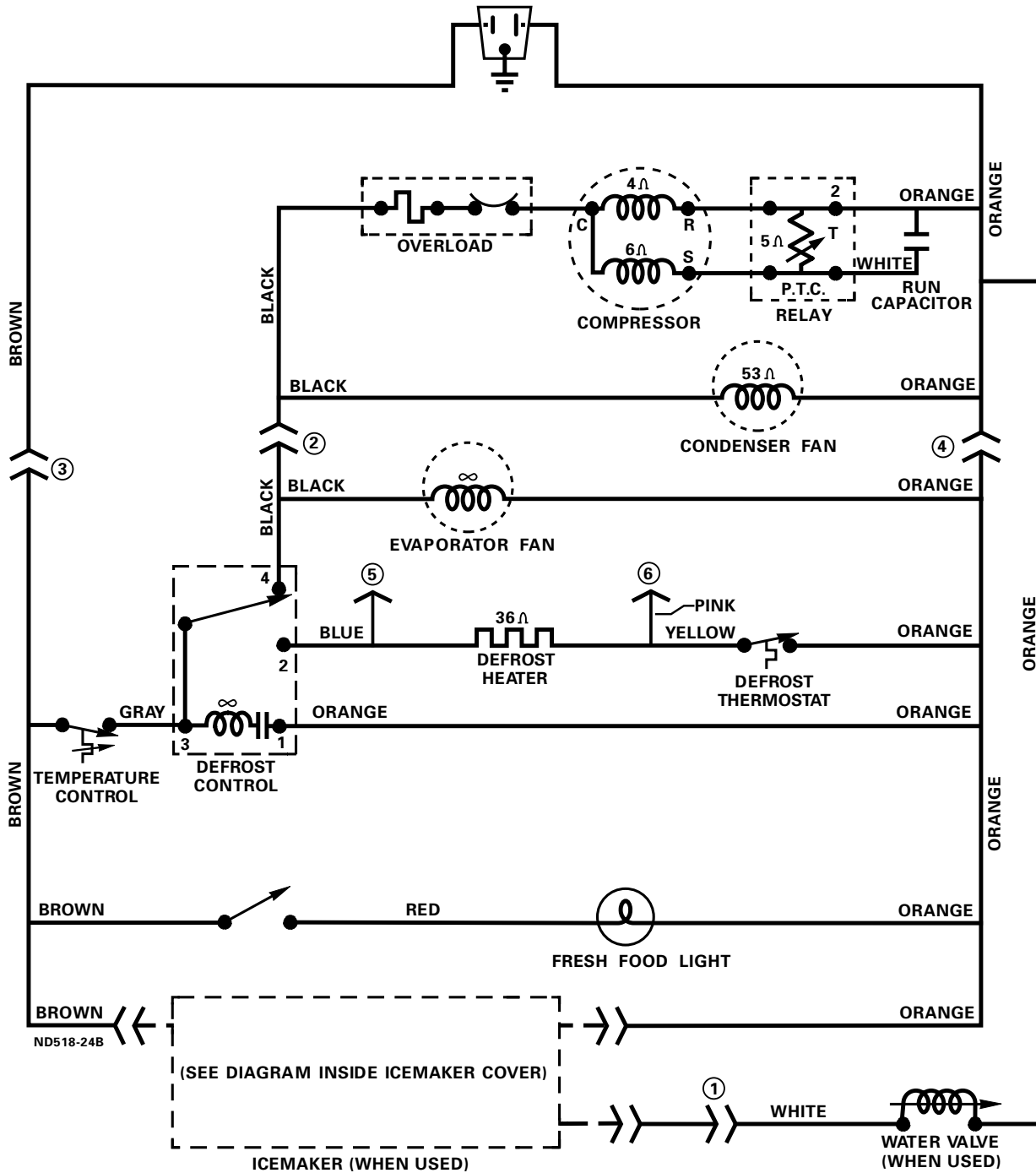

17-18 Cu. Ft.

